

## SISTEMA DE MONTAJE DE 2 FILAS DE 6 PANELES VERTICALES DE 60 CELDAS INCLINADO 20°

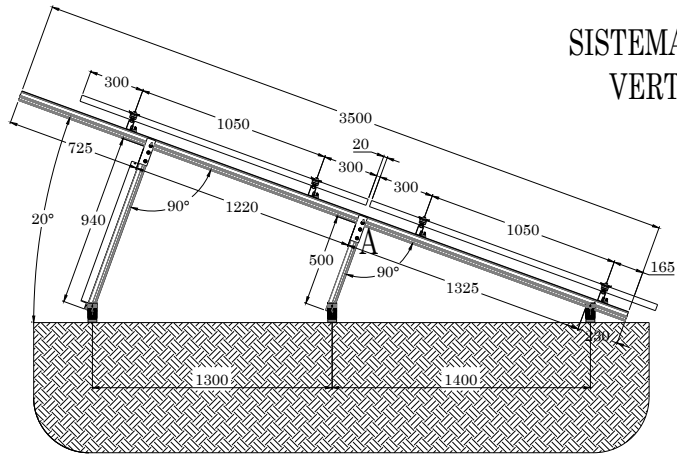

VISTA LATERAL

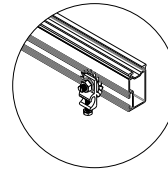

Terminal de  
Conexión a Tierra

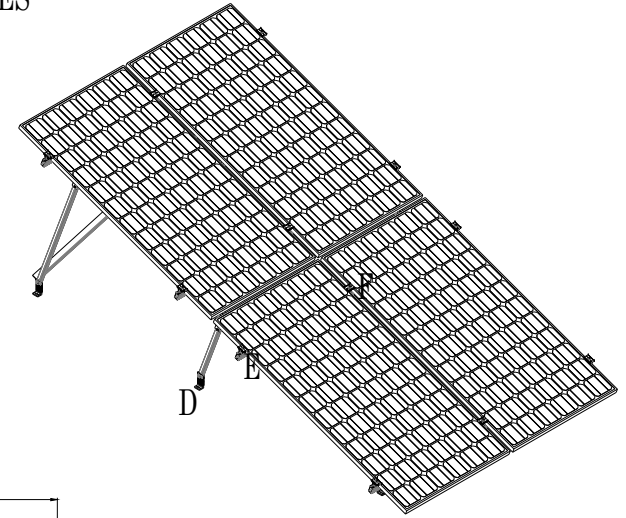

VISTA ISOMÉTRICA

REFUERZO TRASERO  
ÁNGULO RIEL NXT-AR-2000  
CORTADO A 1750MM

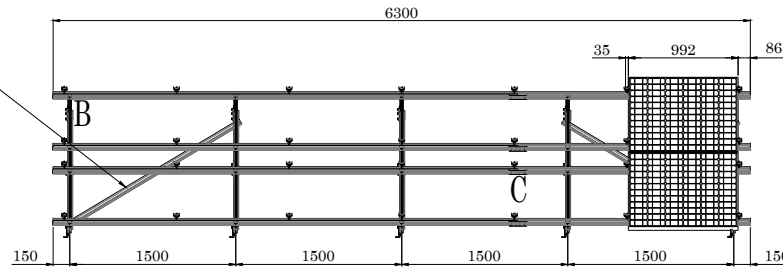

VISTA FRONTAL

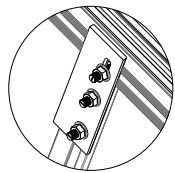

DETALLE A  
Conector Ángulo  
Riel

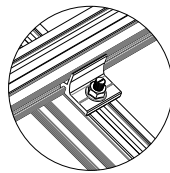

DETALLE B  
Clip de Conexión  
Next-Rail

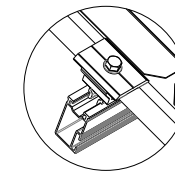

DETALLE E  
Abrazadera Universal  
(Modo Remate)

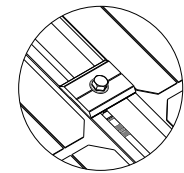

DETALLE F  
Abrazadera Universal  
(Modo Intermedio)

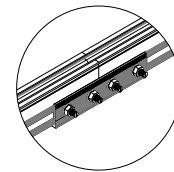

DETALLE C  
Empalme de Riel

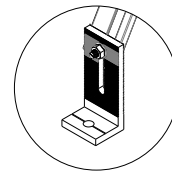

DETALLE D  
Soporte "L"

# Parte	Descripción	Cantidad
NXT-R-2100-MILL	Perfil NextRail 2.1m, mill finish, Aluminio 6105-T6	4
NXT-R-3500-MILL	Perfil NextRail 3.5m, mill finish, Aluminio 6105-T6	5
NXT-R-4200-MILL	Perfil NextRail 4.2m, mill finish, Aluminio 6105-T6	4
NXT-SL-2	2 Soporte L de 105mm para Next-Rail	8
NXT-ER-2	2 Empalmes de riel con puesta a tierra, para Next-Rail	2
NXT-AU-2	2 Abrazadera universal p/panel con marco de 25-40mm	14
NXT-CNTR-4	4 Clips de conexión para Next-Rail	5
NXT-AR-1500	Ángulo-Riel 1.5m, mill finish, Alu 6105-T6	5
NXT-AR-2000	Ángulo-Riel 2.0m, mill finish, Alu 6105-T6	2
NXT-CAR-1	1 Conector de ángulo riel para Next-Rail	10
NXT-TCT-1	1 Terminal de conexión a tierra para Next-Rail	1
NXT-PCT-4	4 Placas de conexión final a tierra (panel-riel)	1
NXT-TB-M8x25-5	5 Tbolt M8x25 Acero Inoxidable con tuerca para Next-Rail	1
NXT-CP-5	5 Clips de Plástico para 2 cables, Next-Rail	3

observaciones:		 Aluminio que transforma	
MATERIAL:		N° DE DIBUJO	NXT-SM-2V6-60
FECHA	08/07/2019		A3
ACOT.	mm [in]		
PESO:		ESCALA NA	HOJA 1 DE 1