

SISTEMA DE MONTAJE DE 2 FILAS DE 6 PANELES VERTICALES DE 72 CELDAS INCLINADO 20°

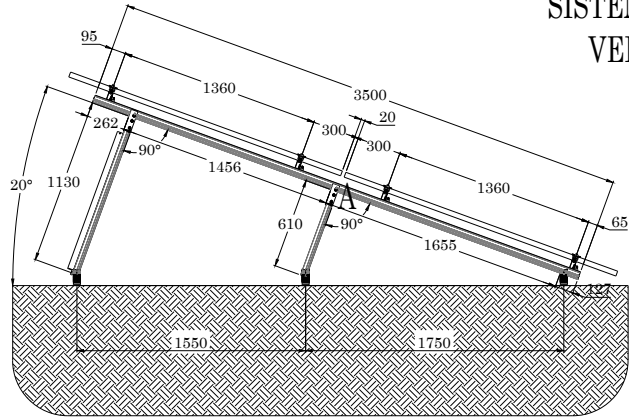

VISTA LATERAL

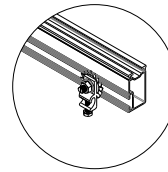

Terminal de
Conexión a Tierra

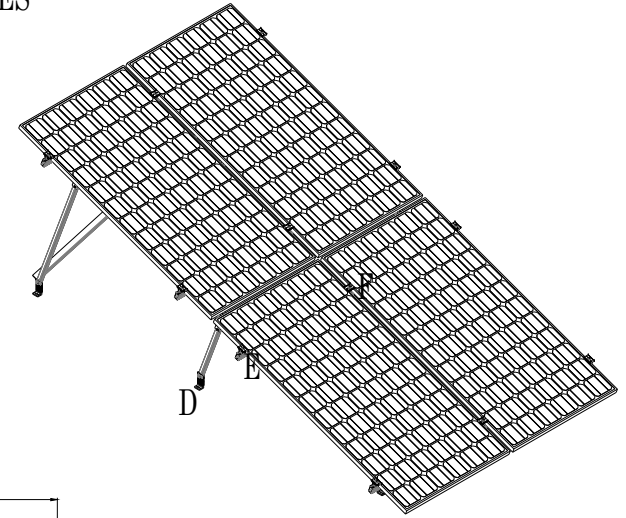

VISTA ISOMÉTRICA

REFUERZO TRASERO
ÁNGULO RIEL NXT-AR-2000
CORTADO A 1850MM

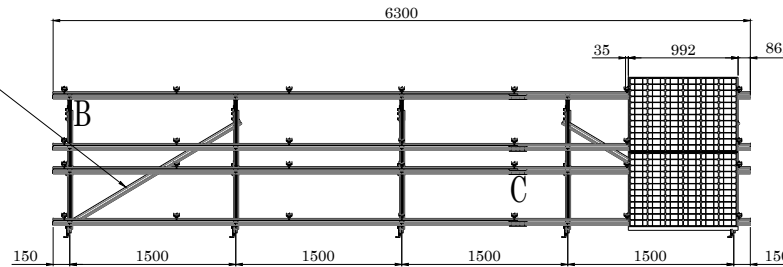

VISTA FRONTAL

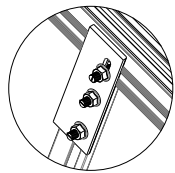

DETALLE A
Conector Ángulo
Riel

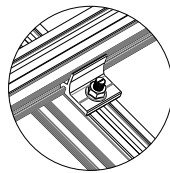

DETALLE B
Clip de Conexión
Next-Rail

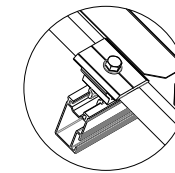

DETALLE E
Abrazadera Universal
(Modo Remate)

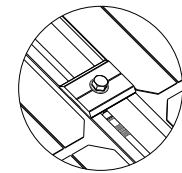

DETALLE F
Abrazadera Universal
(Modo Intermedio)

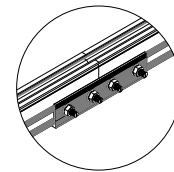

DETALLE C
Empalme de Riel

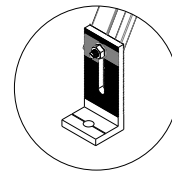

DETALLE D
Soporte "L"

# Parte	Descripción	Cantidad
NXT-R-2100-MILL	Perfil NextRail 2.1m, mill finish, Aluminio 6105-T6	4
NXT-R-3500-MILL	Perfil NextRail 3.5m, mill finish, Aluminio 6105-T6	5
NXT-R-4200-MILL	Perfil NextRail 4.2m, mill finish, Aluminio 6105-T6	4
NXT-SL-2	2 Soporte L de 105mm para Next-Rail	8
NXT-ER-2	2 Empalmes de riel con puesta a tierra, para Next-Rail	2
NXT-AU-2	2 Abrazadera universal p/panel con marco de 25-40mm	14
NXT-CNTR-4	4 Clips de conexión para Next-Rail	5
NXT-AR-2000	Ángulo-Riel 2.0m, mill finish, Alu 6105-T6	7
NXT-CAR-1	1 Conector de ángulo riel para Next-Rail	10
NXT-TCT-1	1 Terminal de conexión a tierra para Next-Rail	2
NXT-PCT-4	4 Placas de conexión final a tierra (panel-riel)	2
NXT-TB-M8x25-5	5 Tbolt M8x25 Acero Inoxidable con tuercas para Next-Rail	1
NXT-CP-5	5 Clips de Plástico para 2 cables, Next-Rail	3

observaciones:		 Aluminio que transforma	
MATERIAL:		N° DE DIBUJO	NXT-SM-2V6-72
FECHA	03/07/2019	ESCALA NA	A3
ACOT.	mm [in]		
PESO:			H0A1 DE 1