

# SISTEMA DE MONTAJE DE 6 PANELES INCLINADO 15 - 30° 72 CELDAS

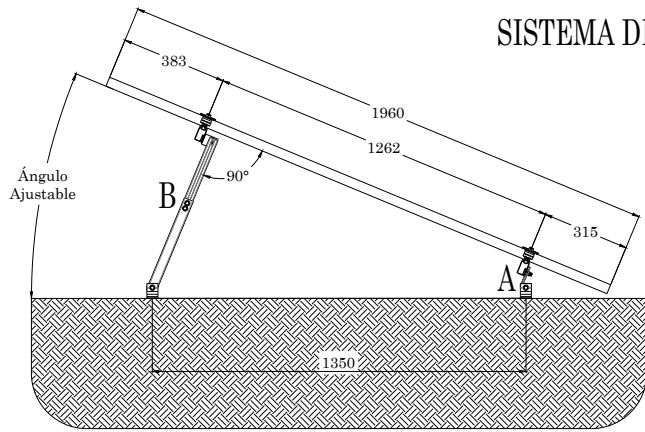

VISTA LATERAL

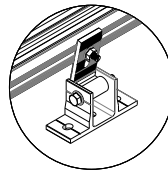

DETALLE A  
Soporte Frontal  
Ajustable

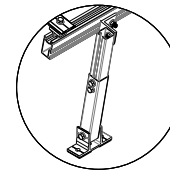

DETALLE B  
Soporte Trasero  
Ajustable

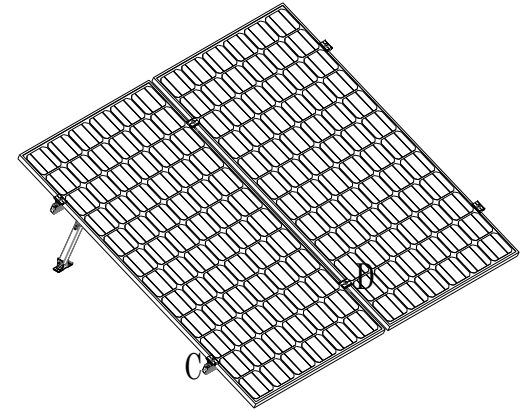

VISTA ISOMÉTRICA

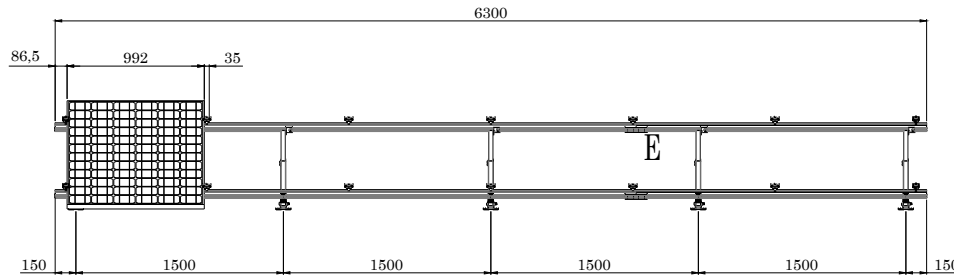

VISTA FRONTAL

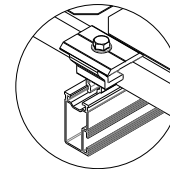

DETALLE C  
Abrazadera  
Universal  
(Modo Remate)

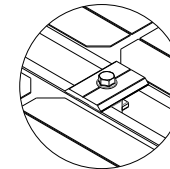

DETALLE D  
Abrazadera  
Universal  
(Modo Intermedio)

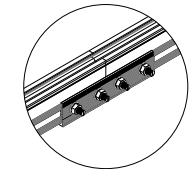

DETALLE E  
Empalme de Riel

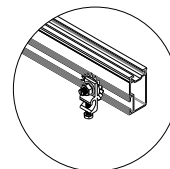

Terminal de  
Conexión a Tierra

# Parte	Descripción	Cantidad
NXT-R-2100-MILL	Perfil NextRail 2.1m, mill finish, Aluminio 6105-T6	2
NXT-R-4200-MILL	Perfil NextRail 4.2m, mill finish, Aluminio 6105-T6	2
NXT-ER-2	2 Empalmes de riel con puesta a tierra, para Next-Rail	1
NXT-AU-2	2 Abrazadera universal p/panel con marco de 25-40mm	7
NXT-TCT-1	1 Terminal de conexión a tierra para Next-Rail	1
NXT-PCT-4	4 Placas de conexión final a tierra (panel-riel)	1
NXT-CP-5	5 Clips de Plástico para 2 cables, Next-Rail	3
NXT-SFA-1	1 Soporte frontal ajustable para Next-Rail	5
NXT-STA-15/30-1	1 Soporte trasero ajustable 15-30° para Next-Rail	5

observaciones		 Aluminio que transforma	
MATERIAL:		N° DE DIBUJO	A3
FECHA	25/06/2019	NXT-SMI-6-30-72	
ACOT.	mm [in]		
PESO:		ESCALA NA	H01A1 DE 1